

---

# An Introduction to F.O.W.T. (Floating Offshore Wind Turbines)



## Lillehammer Energy Claims Conference

Mike McMahon  
Deputy Managing Director  
CTA, Natural Resources – UK

8 March 2018

**Charles**  
**Taylor**  
ADJUSTING

# OVERVIEW

- PRACTICAL MATTERS
  - DESIGN
  - CONSTRUCTION

...but first...



# OFFSHORE WIND

15 GW INSTALLED CAPACITY

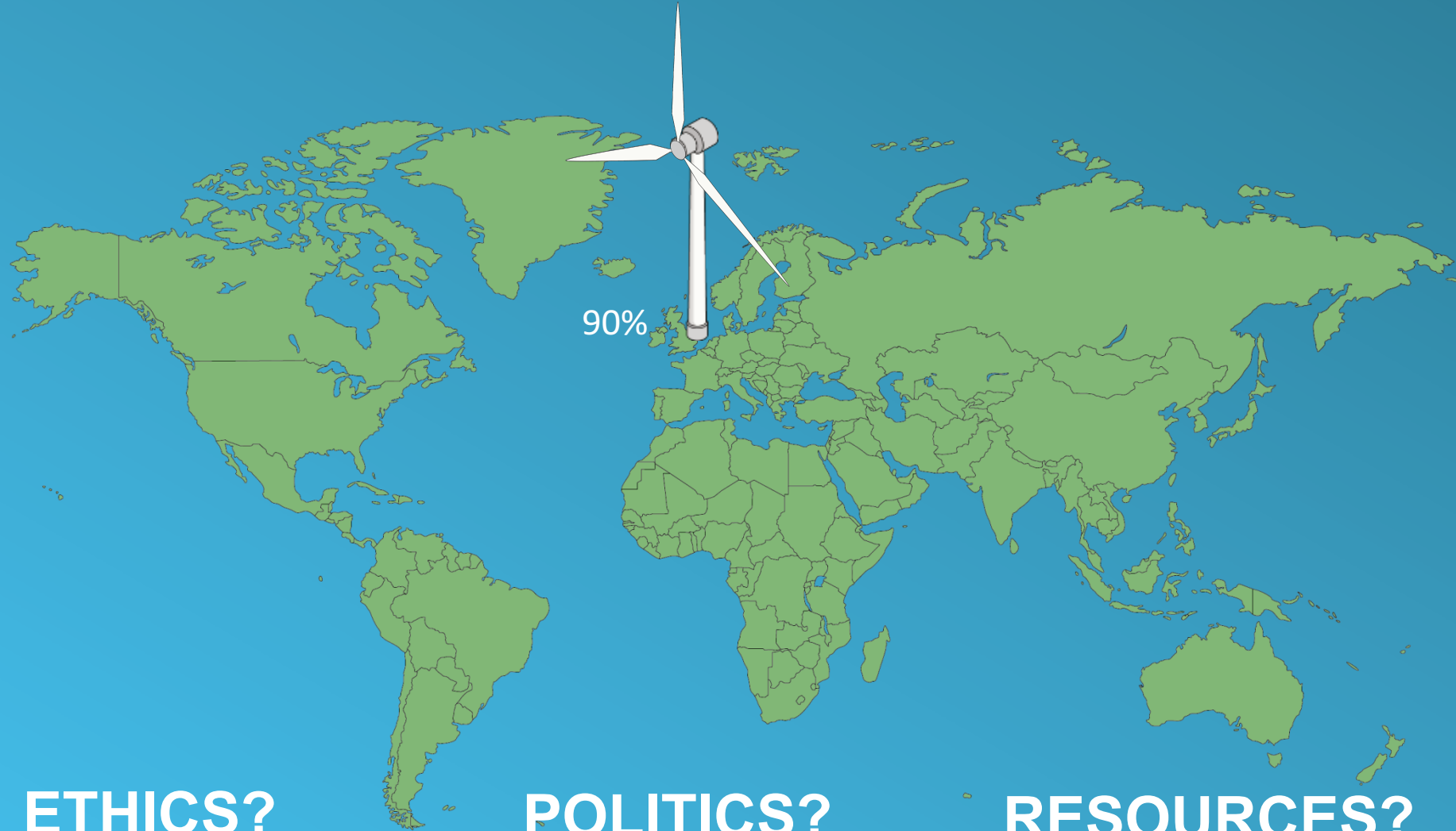

ETHICS?

POLITICS?

RESOURCES?

# PRACTICAL MATTERS

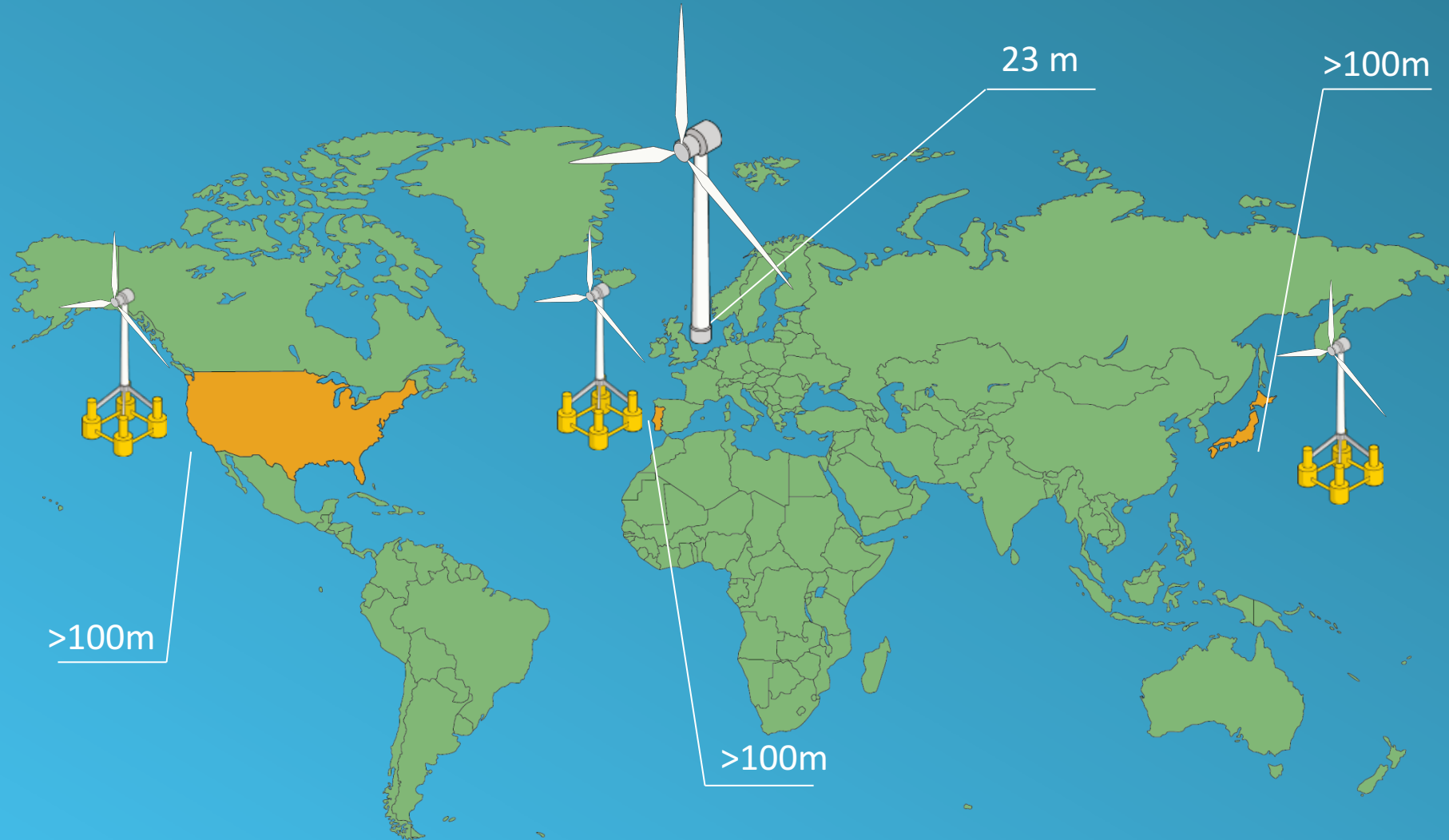

# FLOATING SOLUTIONS

>25 TEST PROJECTS

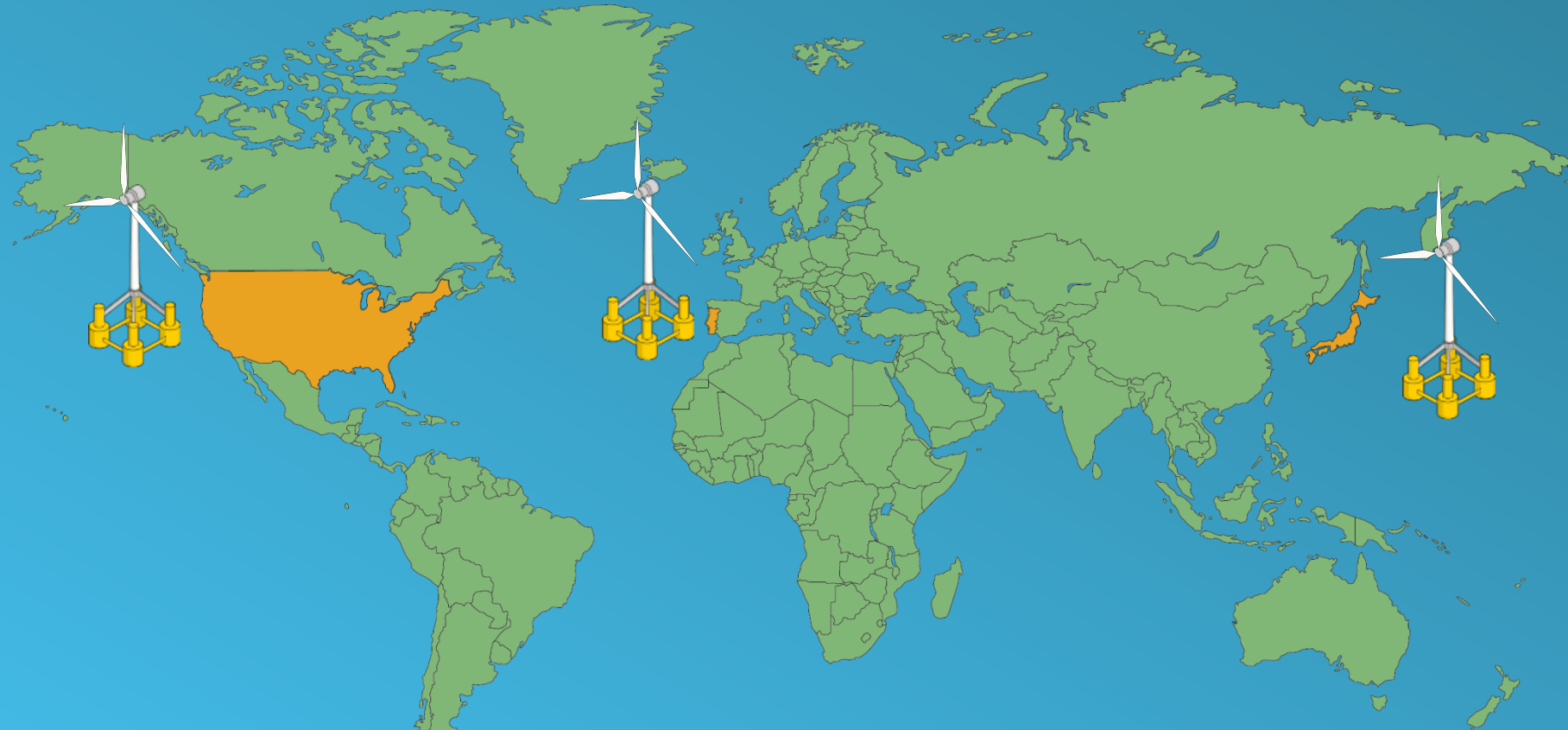

**TENSION LEG (TLP)**

**SPAR**

**SEMI-SUB**

# QUESTION

EXCLUDING FPSOs, HOW MANY FLOATING PRODUCTION SYSTEMS ARE PRESENTLY IN OPERATION GLOBALLY?

- A. ABOUT 100
- B. BETWEEN 100 AND 300
- C. BETWEEN 300 AND 500
- D. OVER 500

Charles  
Taylor  
ADJUSTING

Crew

Hydrocarbons

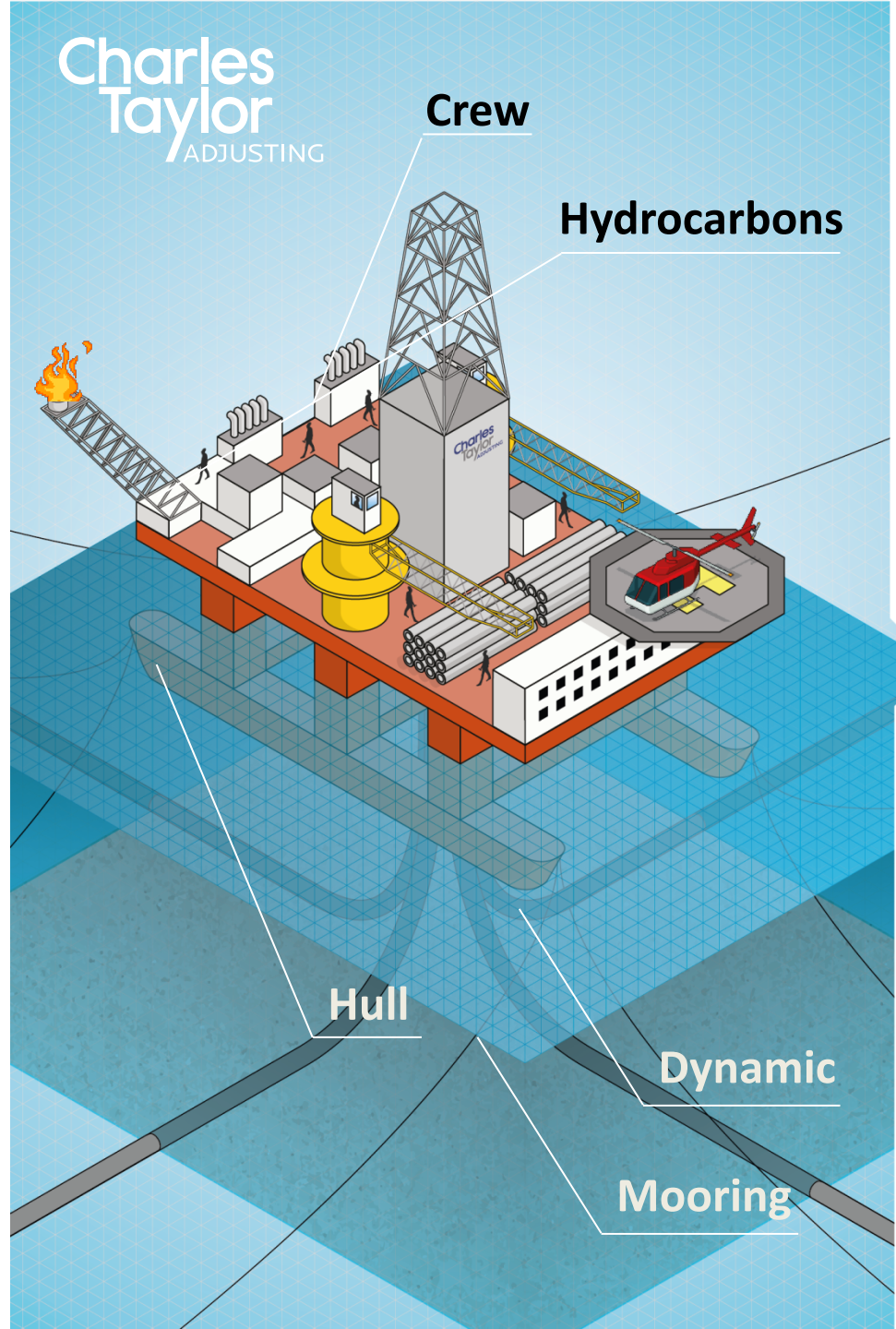

Hull

Dynamic

Mooring

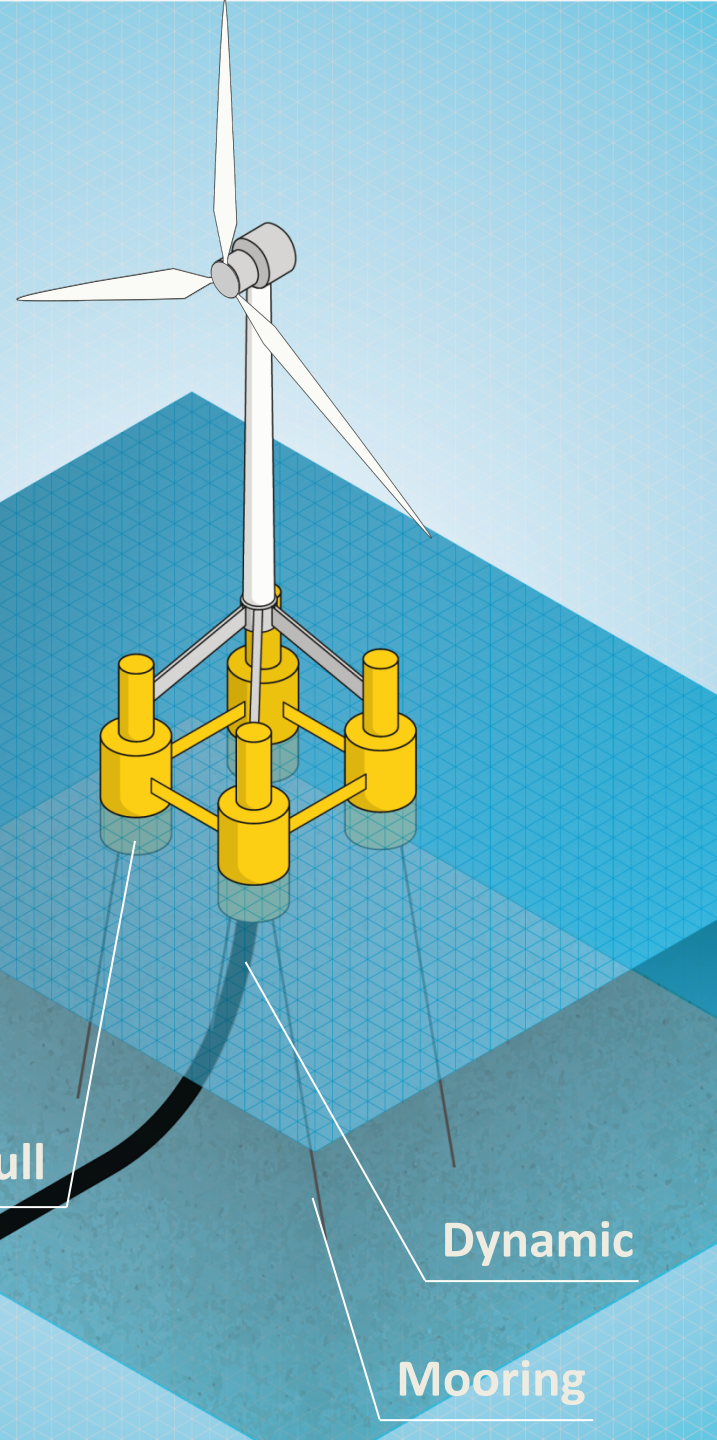

Hull

Dynamic

Mooring

# INTACT STABILITY

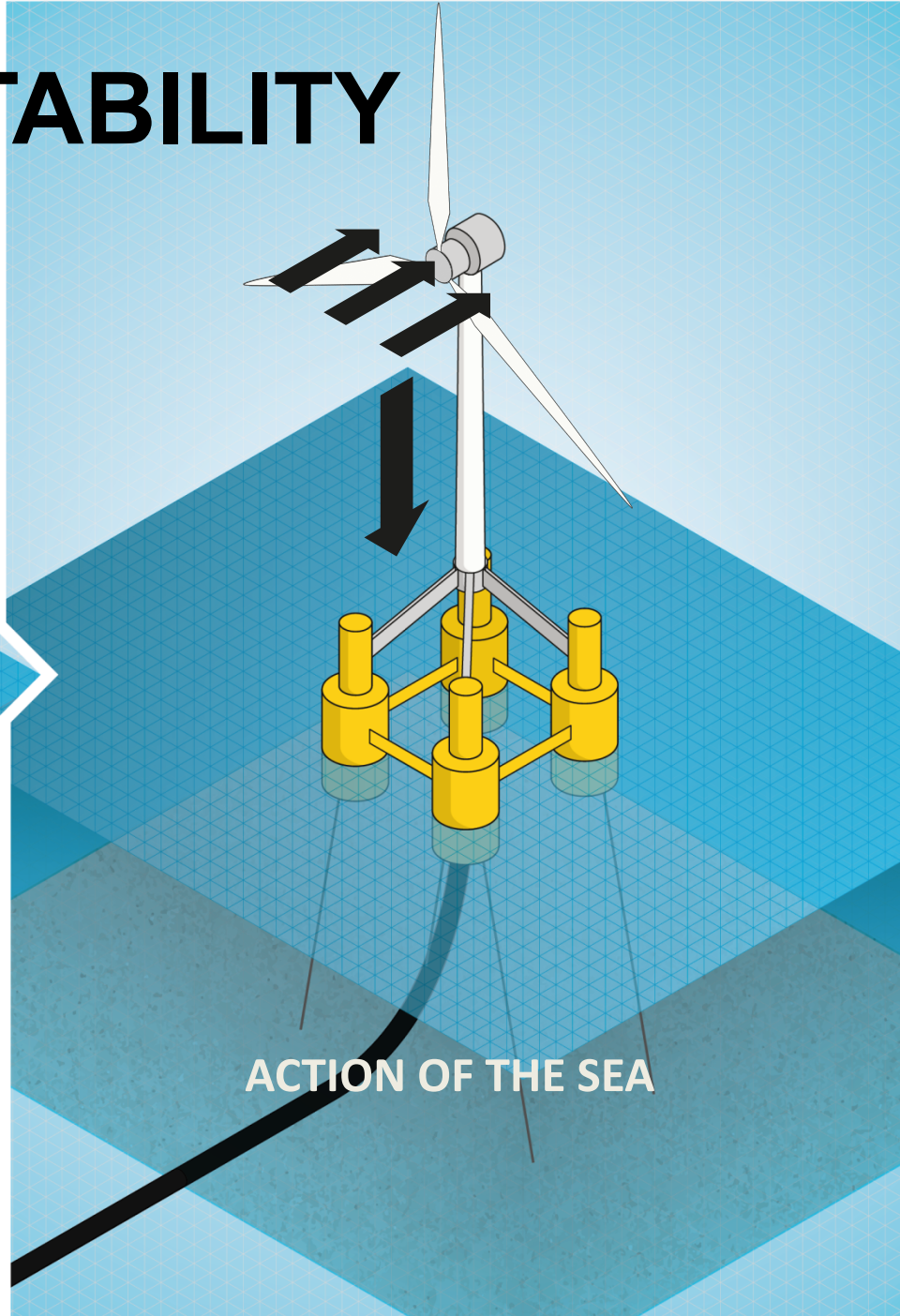
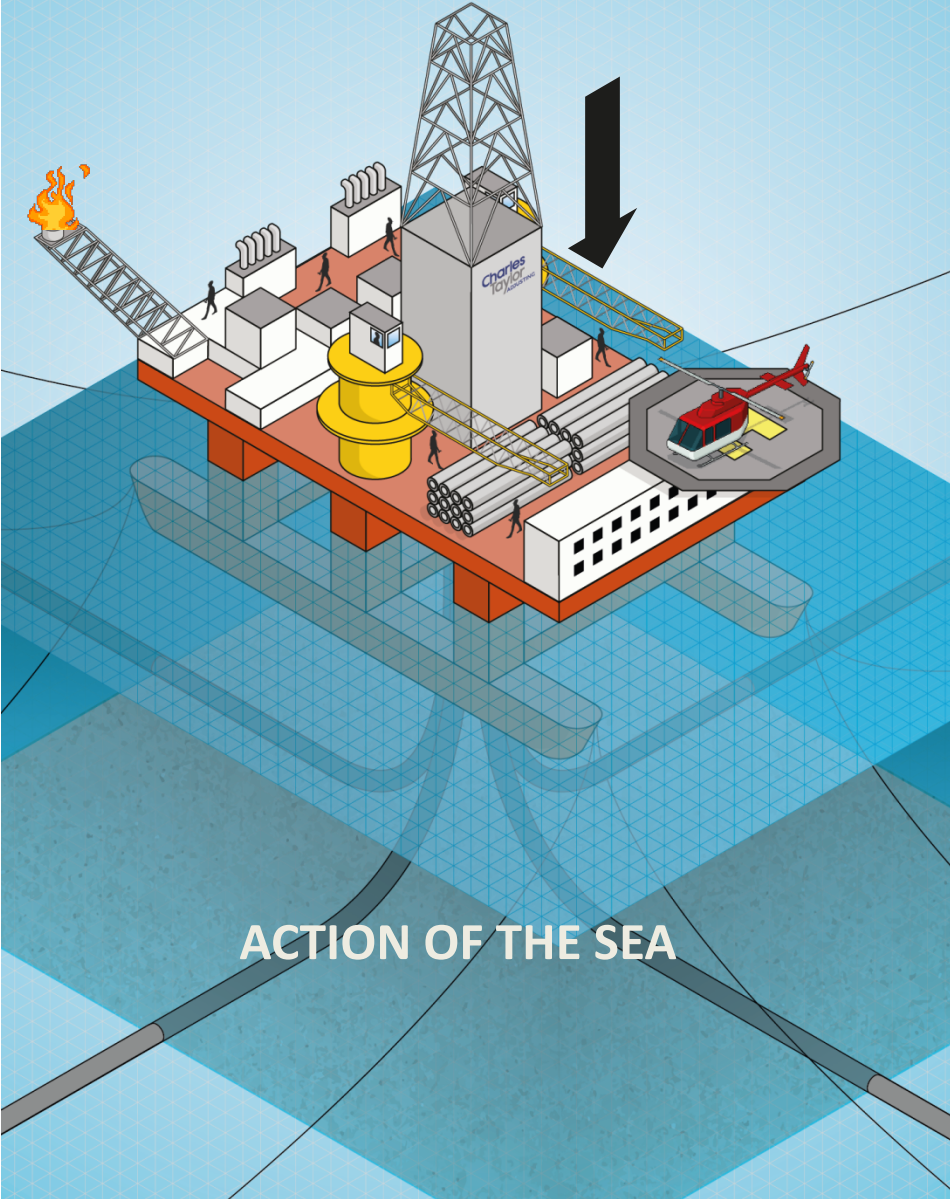



# QUESTION

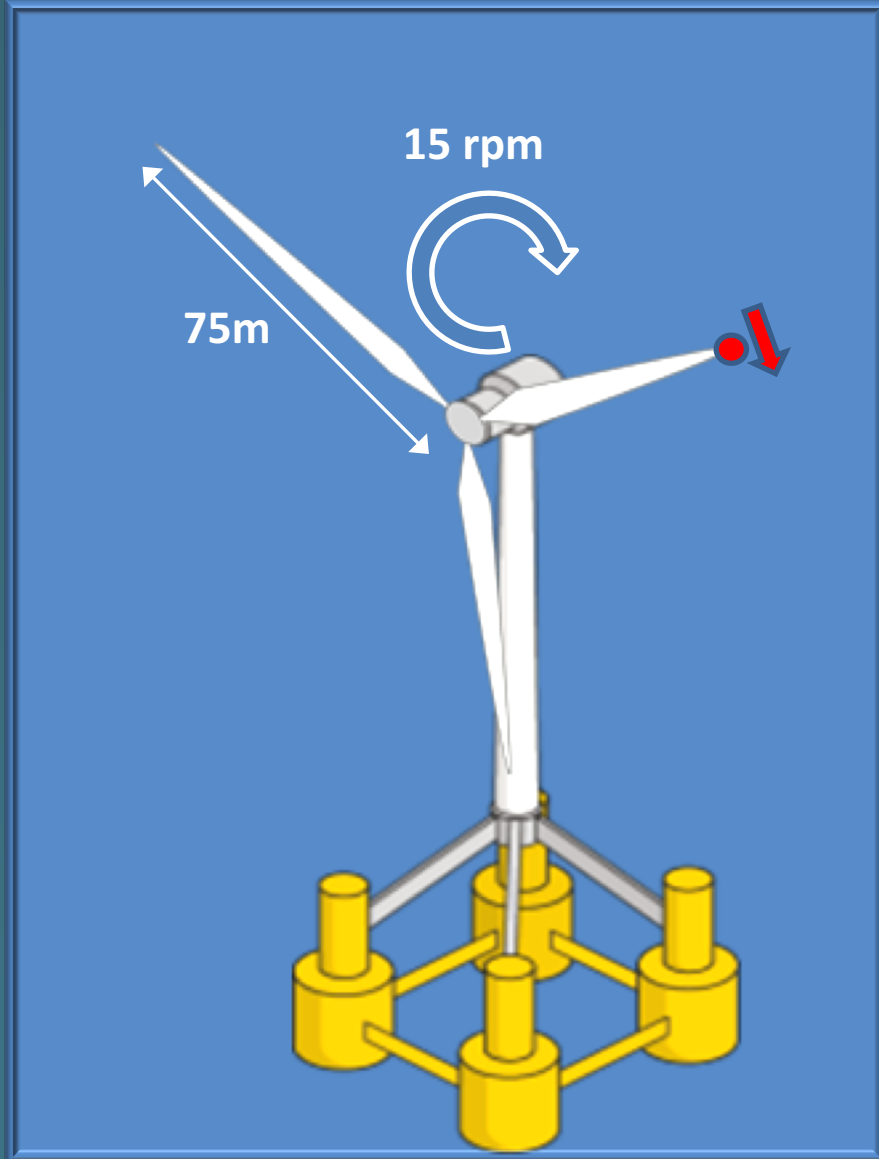

WHAT SPEED IS THE BLADE TIP TRAVELLING AT?

- A. ABOUT 50 KPH
- B. BETWEEN 100 AND 200 KPH
- C. BETWEEN 200 AND 400 KPH
- D. OVER 400 KPH

**MINIMISE ACCELERATION**

**KEEP VERTICAL**

**ACTIVE BALLAST**

**HEAVE PLATES**

**ENHANCED MOORINGS**

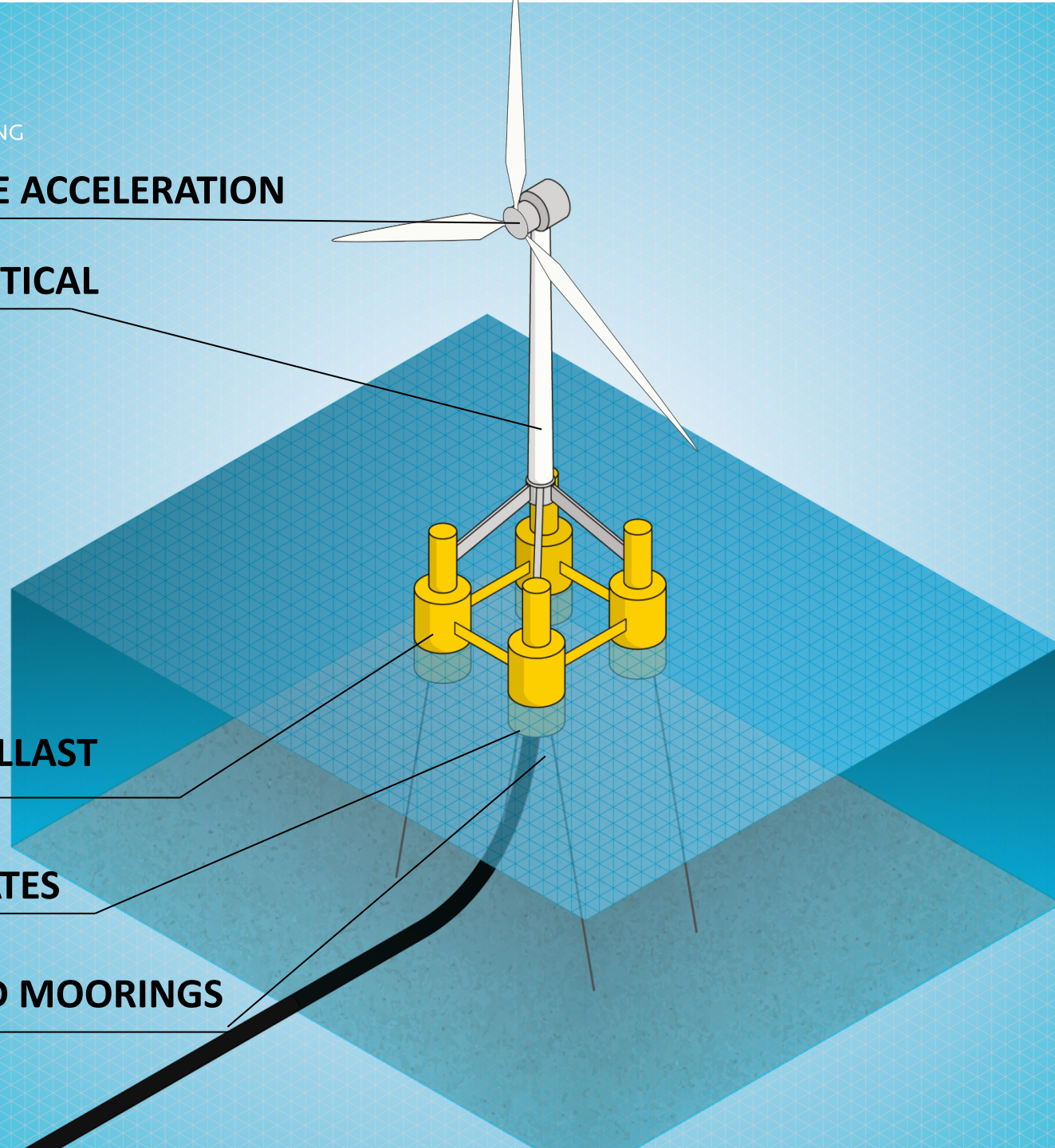

# DAMAGE STABILITY



\$\$\$

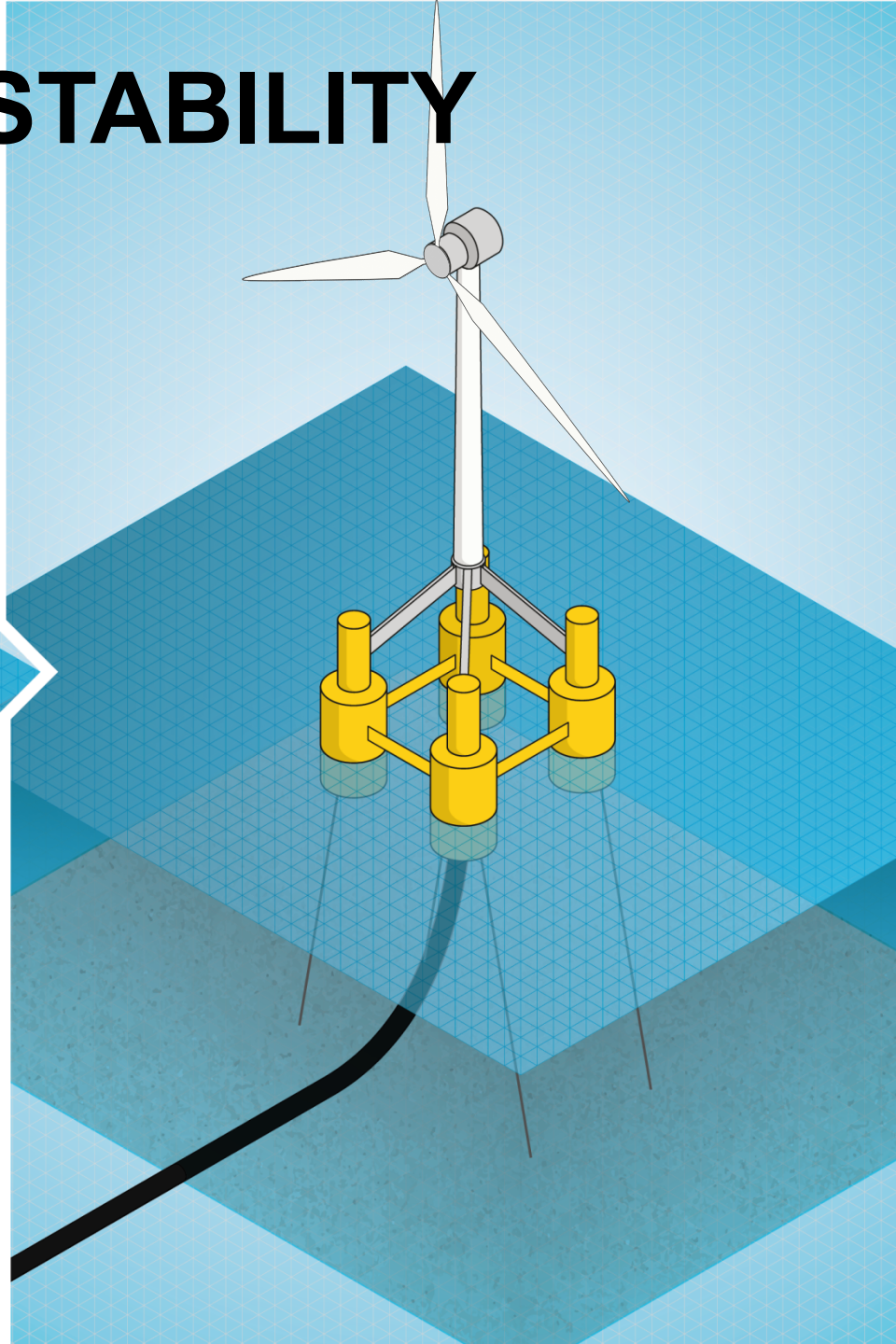

Charles  
Taylor  
ADJUSTING

# DAMAGE STABILITY

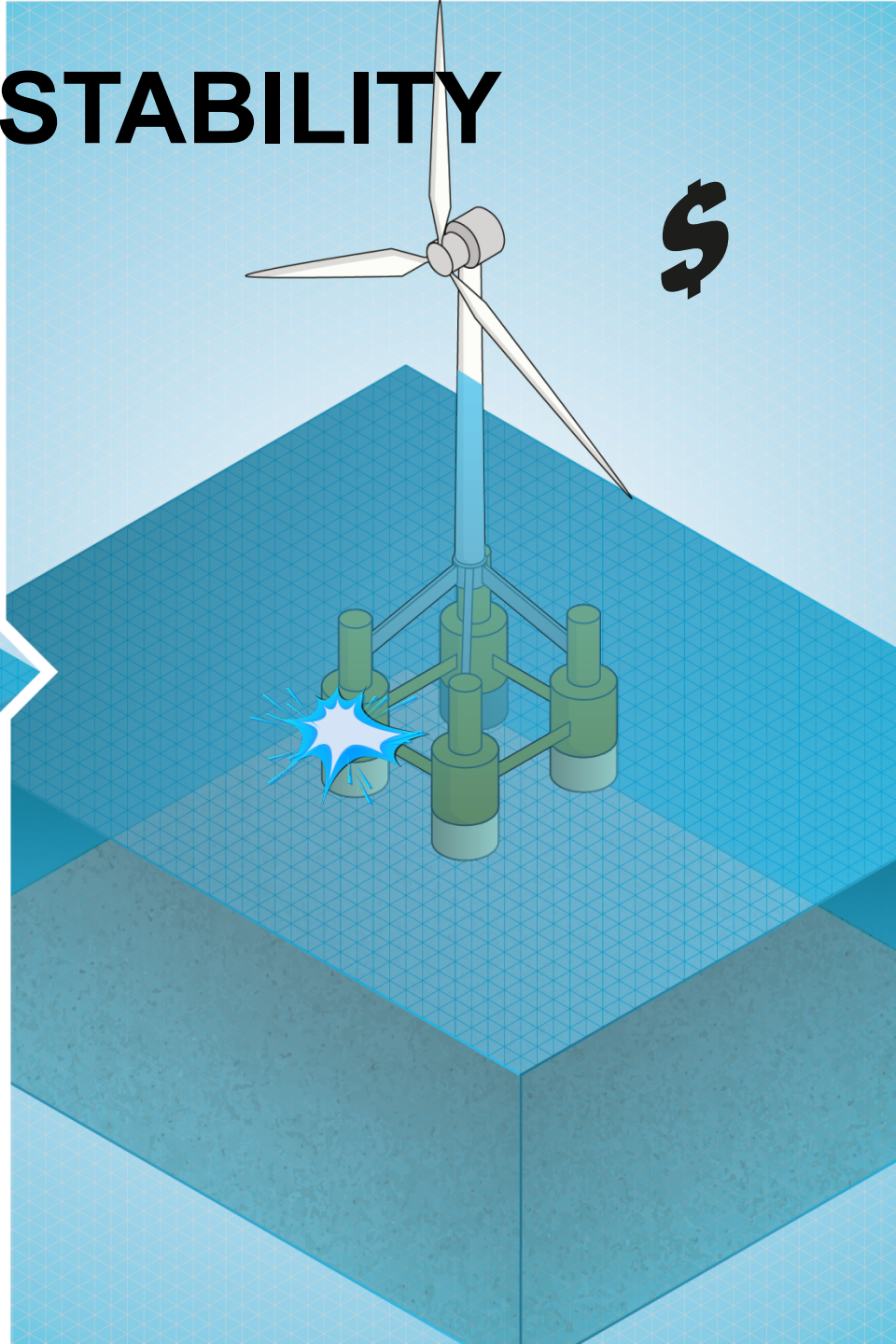

Shared  
Anchors

Mooring

500MW : 50 to 100 Foundations

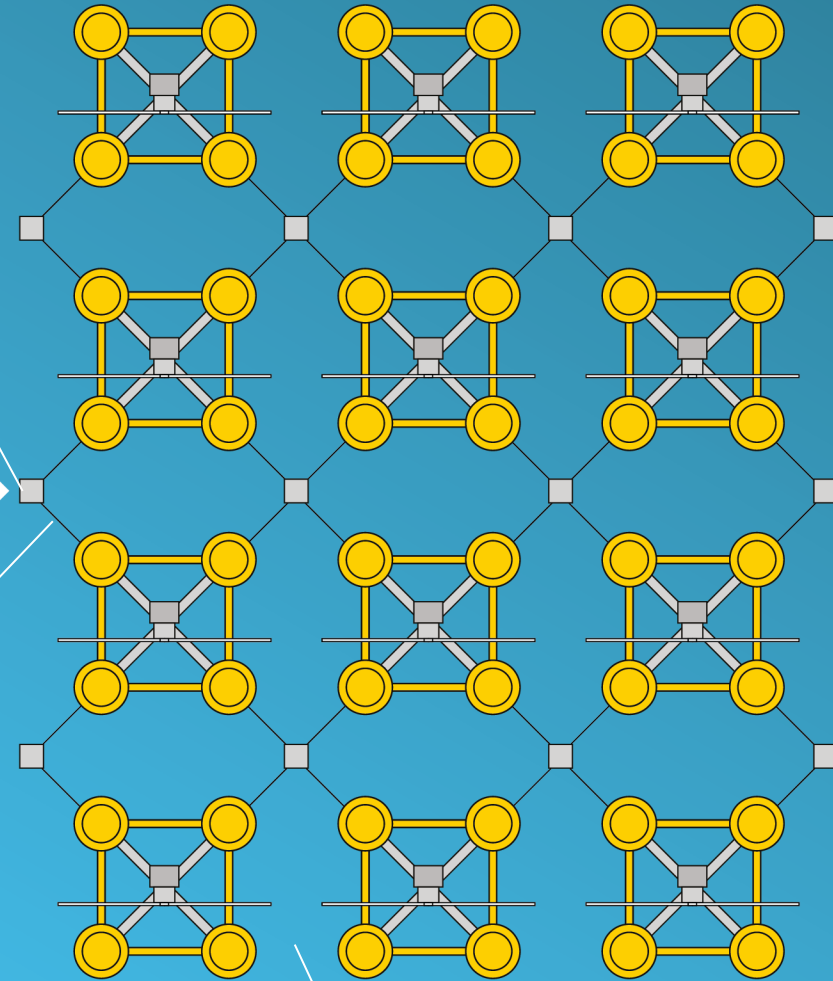

10 x Rotor Ø

# CONSTRUCTION

## FPS

10 X '000S TONNES ✓

MILLIONS OF  
MANHOURS ✓

UNIQUE / ONE-OFF ✓

PRODUCT DRIVEN ✓

INTERNATIONAL  
DELIVERY ✓

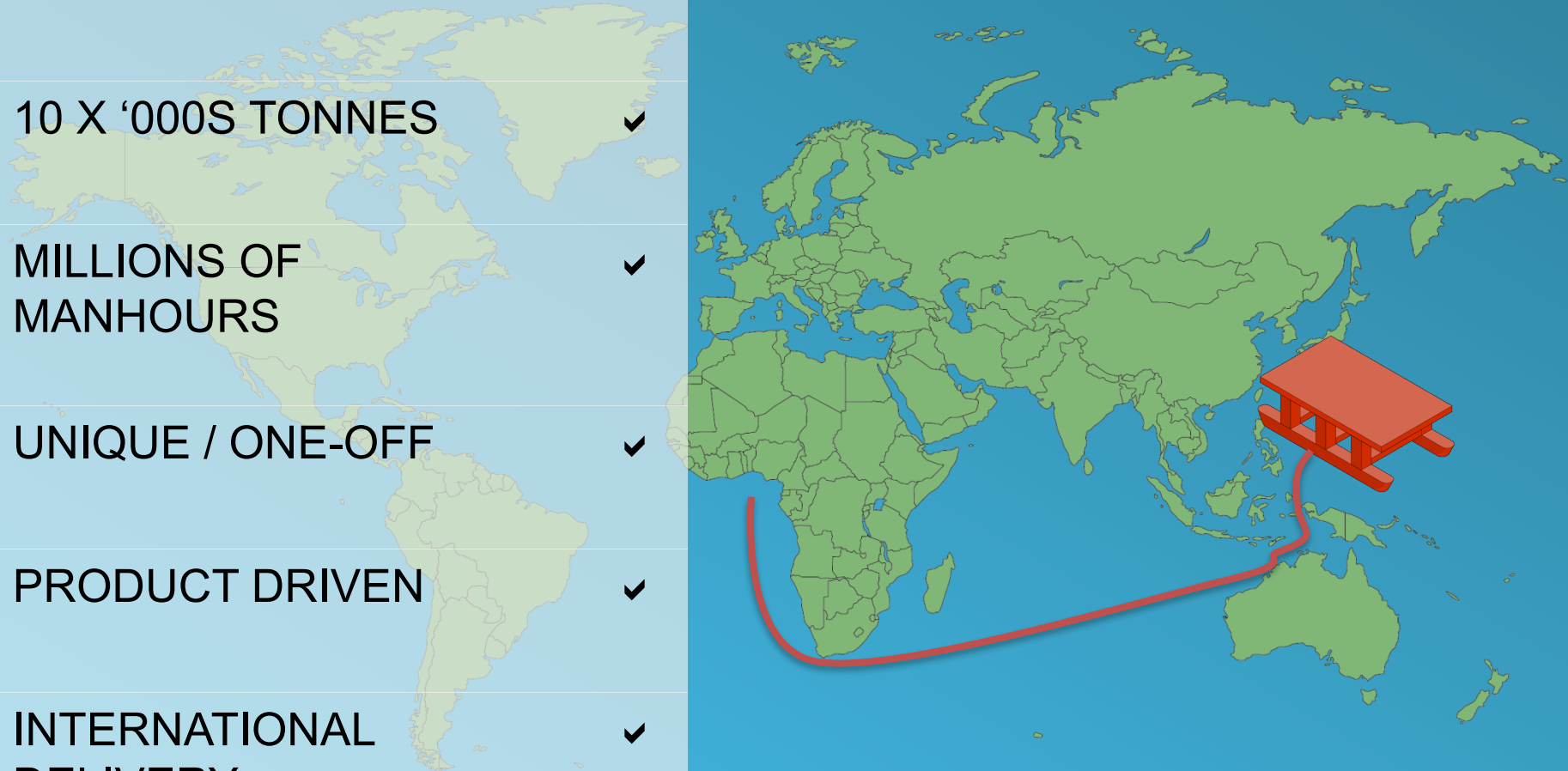

# CONSTRUCTION

## FOWT

10 X '000S TONNES



MILLIONS OF  
MANHOURS



UNIQUE / ONE-OFF



PRODUCT DRIVEN



INTERNATIONAL  
DELIVERY



# IN SUMMARY

HARNESSING WIND POWER

DEEPWATER CHALLENGES

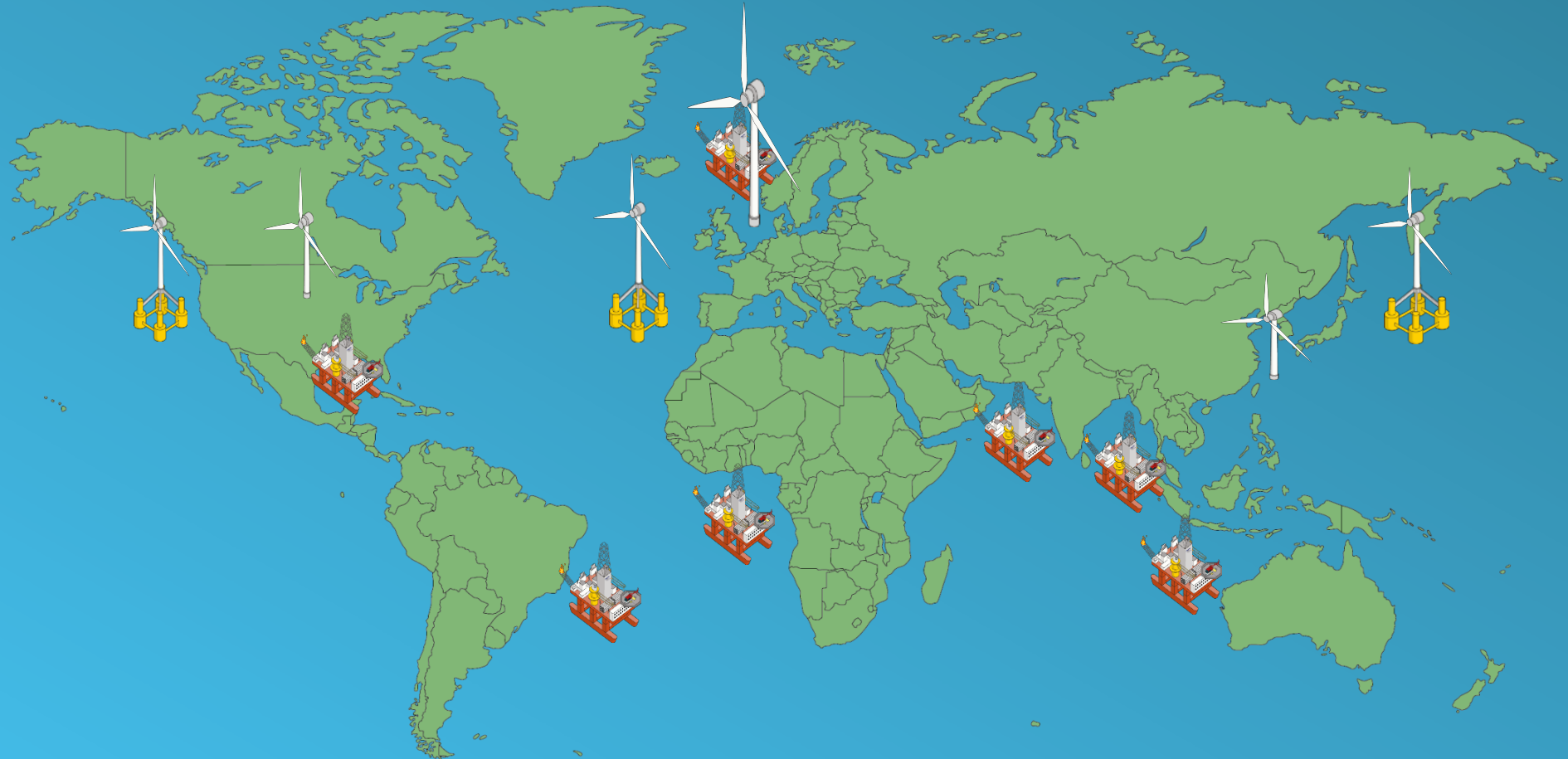



# THANK YOU

Disclaimer: This presentation is intended to provide a general update on its subject matter and is for guidance purposes only. Nothing in this presentation shall constitute legal or other advice and should not be relied upon as such. Any information within this presentation referring to statute, law, regulation, guidance or any other publication should not be regarded as a substitute for reading in full and seeking professional advice on the relevant statute, law, regulation, guidance or other publication and any amendments to such documentation from time to time. Charles Taylor shall have no liability for any loss arising from any reliance on the information provided in this presentation.

---

## Charles Taylor plc



[www.ctplc.com/adjusting](http://www.ctplc.com/adjusting)



[www.linkedin.com/company/charles-taylor-plc](http://www.linkedin.com/company/charles-taylor-plc)



[@ctaylorplc](https://twitter.com/ctaylorplc)

Charles  
Taylor  
ADJUSTING